

Cat Scratching Post with Bed

Smart Reminder:

Do not fully tighten the screws during initial assembly. Lightly secure each component first, then tighten all screws after the entire structure is assembled.

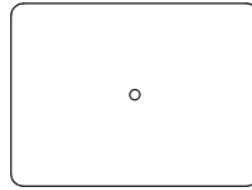

A

Base Platform

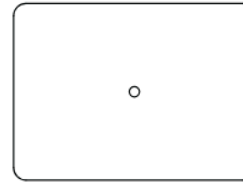

B

Supporting Board

Supporting Board B is slightly smaller than Base Platform A.
Ensure correct placement during assembly.



C

Post

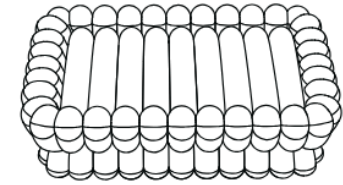

D

Cushion Bed



E

Tassel Toy

- 1** Attach planks A and B to both ends of column C using bolts R. Ensure all parts are aligned before tightening.

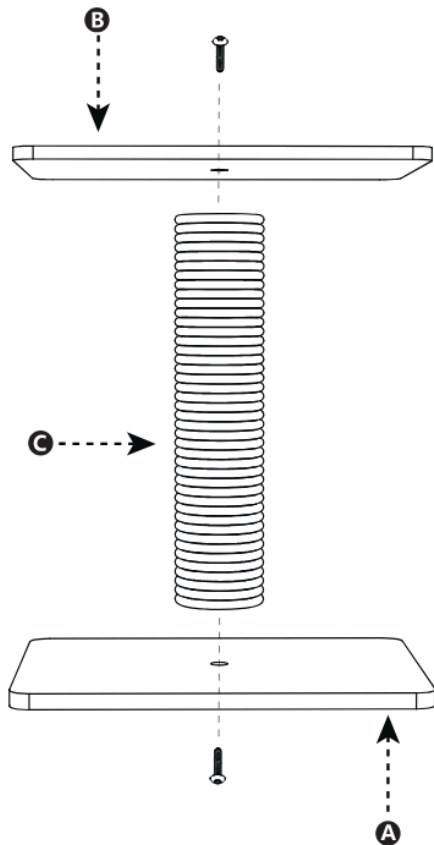

R*2

- 2** Place the cushion D securely on top of the supporting board B, ensuring it is centered and fully wrapped around the edges.

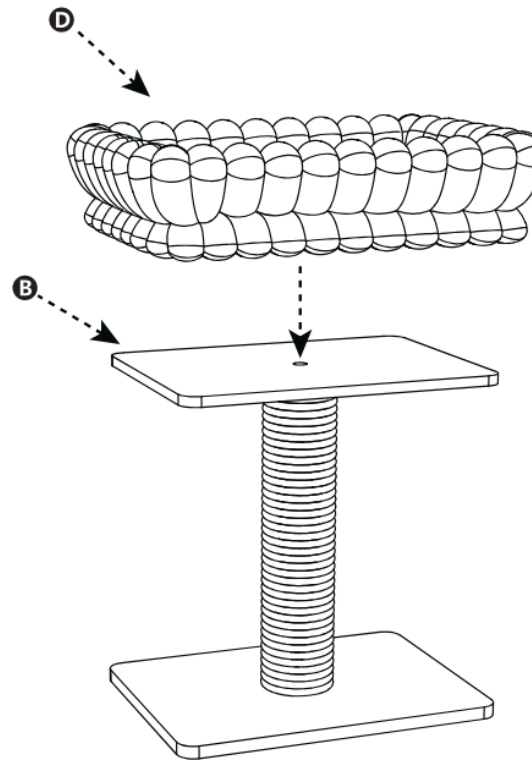

- 3** Attach tassel toy E to the side loop of the nest mat to complete the installation.

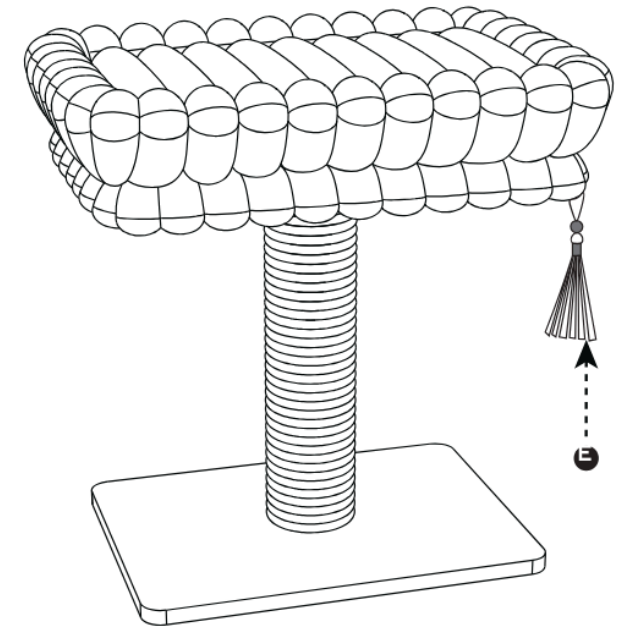



PATHOSIO PETS

Cat Scratching Post *with Bed*

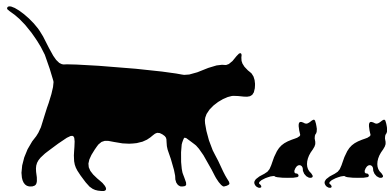
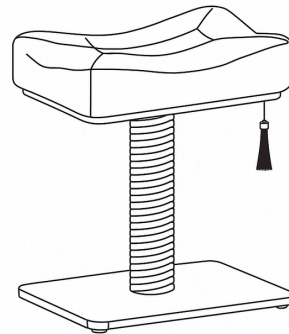

Got a question or comment?
Scan the QR code and drop us a quick message.
We'll be right with you!

